



Summit SWM908 Tx Development Kit

With Summit SD Tx Module

HARDWARE PRODUCT BRIEF

Development Kit Description

The Summit SWM908SD Tx Development Kit (Dev Kit) is designed to speed the development of audio systems that include a Summit Wireless SWM908SD Tx Module for the development of speakers based on any Summit SWS997 Series Rx Modules. Using this Dev Kit, engineers can begin application firmware work immediately, before any custom hardware is ready. The Dev Kit's Glenwood Bridge board provides all the required power, reset/control, and I2S audio connectivity for the Summit SWM908SD Tx Module. Connecting I²S (or optional analog) audio and starting a session on the included Raspberry Pi credit-card-sized computer is about all that is required to begin using the Dev Kit.

The Standard Distance (SD) module is intended for designing transmitters for bookshelf and tower speakers in Home Theater applications.

Development Kit Features

- Provides power and reset functionality to the Summit Tx Module
- I2S input header allows direct I2S input of four signal pairs (eight channels)
- I2C header allows for control of the Tx Module using the Summit Wireless I2C API
- UART output for debug logs
- Buffered I2S output for I2S monitoring
- Eight analog inputs with 24-bit 48 kHz DAC (with optional analog input board)

Development Kit Contents

- Summit Wireless SWM908SD Tx Module with integrated antenna
- Summit Wireless Development Kit digital interface board
- External power supply
- Raspberry Pi Model B credit-card-sized computer
- Raspberry Pi to digital interface board control cable
- USB AC – 5 VDC adapter
- Assembled on Plexiglas base

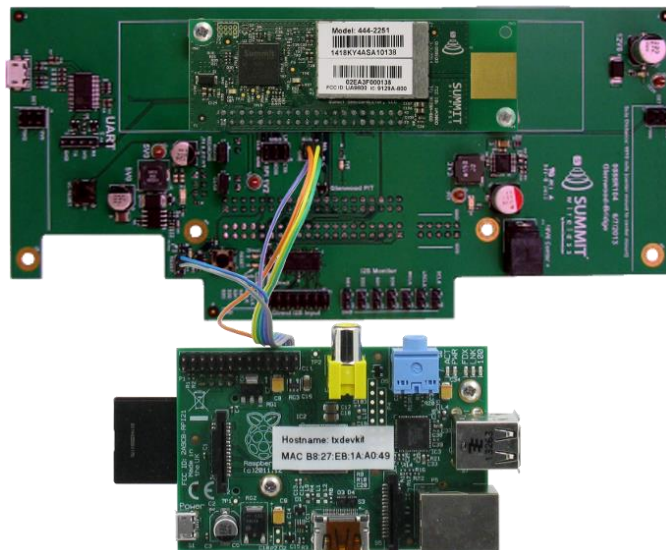

Summit SWM908 Tx Development Kit (without optional analog input board)



Summit SWM908 Tx Development Kit

With Summit SD Tx Module

HARDWARE PRODUCT BRIEF

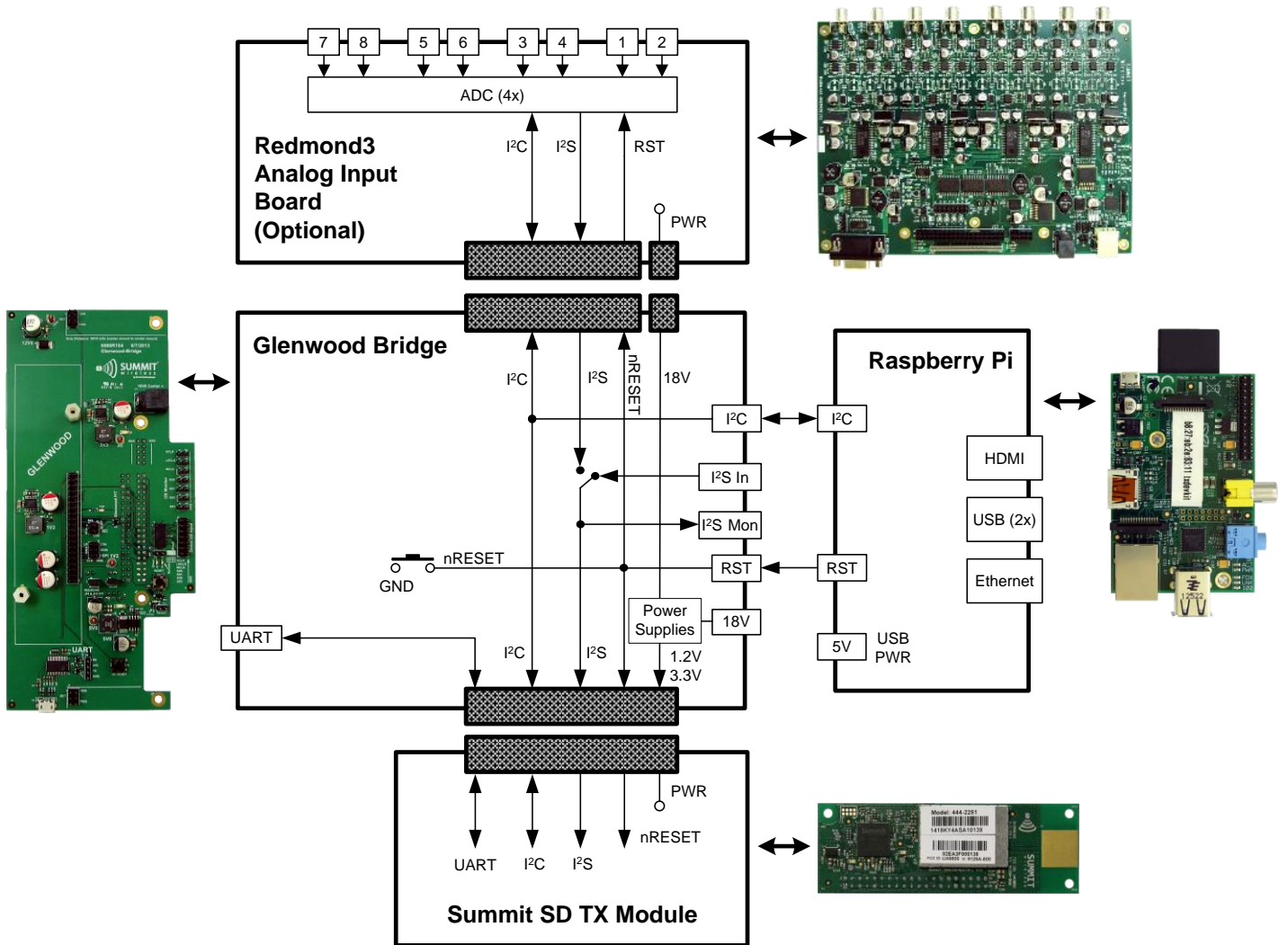

Summit SD Tx Development Kit Block Diagram

Ordering Information

Description	Digital Input Only	Digital and Analog Input
Summit Wireless SWM908SD Tx Development	444-2262	444-2263



Summit Wireless Technologies, Inc.
 8875 NE Von Neumann Dr., Suite 100
 Hillsboro, OR 97006 USA
 Phone 503 615-7700
 Fax 503 615-4232
 Email info@summitsemi.com

©2014 – 2020 Summit Wireless Technologies, Inc.
 Specifications are subject to change. All brand and product names are trademarks of their respective companies.